

Corte A-A
Eixo de entrada

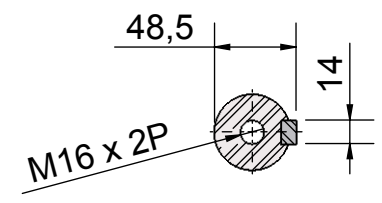

Corte B-B
Eixo de saída

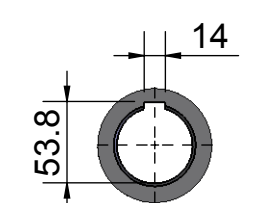

Detalhe C
Eixo de saída vazado

Acessórios para fixação

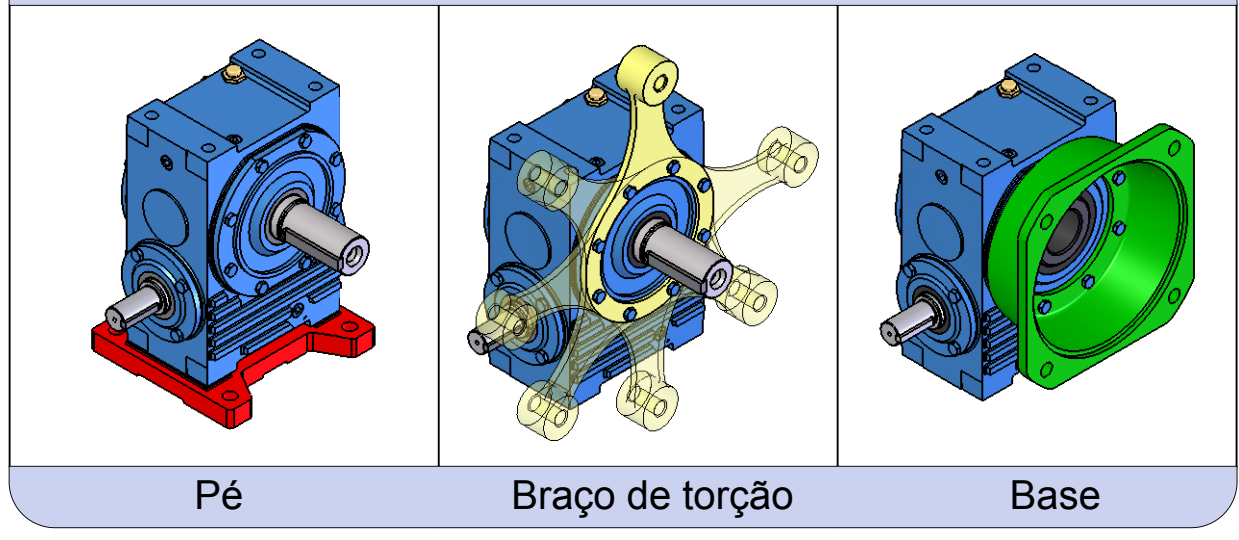

Pé

Braço de torção

Base

MODELO	Regime de trabalho uniforme 10h/dia, 10 arranques/h		Redução Nominal Tabelada - Padrão de linha									
			10	15	20	25	30	40	50	60	80	
CR-800	Potência máx. admitida na entrada	CV	9,71	6,88	5,72	5,36	4,50	4,24	3,54	2,80	2,08	
	Momento de torção na saída	Kgf.m	34,18	34,91	35,58	39,77	38,25	43,31	40,33	37,82	32,69	
	Rendimento %	h	0,86	0,80	0,76	0,74	0,67	0,64	0,58	0,55	0,48	
	Redução efetiva	i	10,00	15,50	20,00	24,50	31,00	39,00	48,00	60,00	80,00	
	Redução efetiva no eixo de saída	n2	175,00	112,90	87,50	71,43	56,45	44,87	36,46	29,17	21,88	